



THE NEW GENERATION SCANIA

# TAILORED FOR THE PERFECT FIT



**SCANIA**







# HOMeward BOUND WHEREVER YOU GO

This is your life. New routes, unknown territories – or that same familiar scenery passing by. You're living in the moment, in your own space.

We know you can feel it. It's there from the moment you step into the cab; that special sense of quality, and the atmosphere you can only experience in a Scania. Like coming home.

Our new generation Scania is represented in all cab types – from the majestic high-rise S-cab to the agile P-cab. Each one tailored to fit your application to perfection, maximising both business value and pleasure.



# RISING TO EVERY OCCASION

The S-cab breaks new ground in driver comfort and the impressive exterior gives a taste of what you can expect from the inside. Taking a seat in the Scania S-cab is a one-of-a-kind experience. Look around and be captivated by the spaciousness and true craftsmanship throughout, from the smart storage compartments down to the neatest stitch.







# YOUR PARTNER IN MOTION

The R-cab is a premium workhorse, with outstanding comfort and a range of options tailored to your needs. The ideal long-haul companion, the R-cab offers all that you have come to expect from your Scania, and more. Robust, versatile and the perfect fit for your life on the road, wherever it may lead you.





# ALL-ROUND ALL DAY

The G-cab is perfectly balanced in the middle of the new Scania cab range. With excellent visibility, enhanced comfort, and plenty of storage space, it's the premium choice for all-round duty in various applications. A flexible partner that's at home in the toughest construction conditions.







# A LIGHTWEIGHT CHAMPION

The agile P-cab is designed with safety, comfort, and efficiency in mind. Easy entry and exit, together with exceptional manoeuvrability and visibility, make it ideal for urban and regional distribution, yet tough enough for construction and other demanding applications.







# DESIGNED FOR URBAN SERVICES

Tailored for hectic operations in tight city conditions, the L-cab combines a spacious interior with compact exterior measures. Excellent cross-cab access, comfortable kneeling function, and improved visibility make getting in and out of the vehicle quick and easy. An extra feature is the side window on the lower part of the passenger door, helping driver and passengers keep track of nearby pedestrians, children and cyclists.







# ALWAYS READY FOR THE UNEXPECTED

On the road during a call-out, the crew must put on gear and prepare for the assignment on the go. The Scania CrewCab's flexible interior layout, a wide variety of storage possibilities, and excellent lighting features, help the crew to get ready for any emergency. Entry and exit, also with heavy clothing and equipment, is easy thanks to optimally placed doors and grab handles. With these features, the crew can save precious time and better plan ahead to safely complete their mission.













SCANIA

ESE 152



**EXTE**





**ERIOR**



## Exterior

### Improved crash performance

The sturdy cab structure provides improved protection and enhanced safety for cab occupants. The cab is also equipped with several airbags, for extra safety in case of accidents.

### Aerodynamics

Front, roof, side, underbody – all areas have been analysed, adjusted and optimised to streamline air flow and achieve the lowest possible air resistance.

### Windscreen

For increased safety and comfort in cold and snowy conditions, the windscreen is available with electrical heating. The heating function ensures visibility by preventing snow and ice sticking to the outside, as well as condensation forming inside the cab. This is especially suitable in operations where the driver frequently steps in and out of the cab, such as distribution or timber loading.

### Scania configurator

There are excellent opportunities for you to put a stamp on your vehicle and customise your Scania – regardless of your application. Or taste, for that matter. Go to the Scania configurator on [scania.com](https://www.scania.com) and see what options are available on your market.

### External storage

A convenient storage compartment is placed behind the door on both driver's and passenger's side. It is equipped with lighting and has access from both the outside and inside of the cab.



# CARVED TO PERFECTION

The appearance is striking. Robust and straightforward, yet elegant. The new generation Scania sets new standards in terms of driver environment, safety, fuel efficiency and engine power.

#### **Air deflector system**

The roof and side air deflectors are designed to effectively reduce wind resistance from bodywork or semi-trailer. Air deflectors are especially useful for vehicles operating at 50 km/h or more, enabling fuel savings by up to 4%.

#### *Roof air deflector*

The slim roof air deflector is available in three different heights: 5, 25 and 65 cm. There is also an adjustable version, where the angle can be adapted either by manual or electrical operation.

#### *Side air deflector*

Fitted at the rear of the cab, the side air deflectors are available in 12, 45 or 53 cm.



#### **Side skirts**

The side skirts improve both aerodynamics and fuel consumption. They also function as a complement to the under-run protection solution, which consists of two sturdy beams between the front and rear axles, preventing unprotected road users from falling under the truck.

#### **Leading brake performance**

Innovative features, such as improved brake actuation, stronger brake calipers, and better weight distribution contribute to best-in-class brake performance.

## Exterior

### Window rear

An extra window in the back wall of the cab adds extended visibility and sense of space.

### Working lamps

Efficient lighting lets you work safely around the truck. There are working lamps for the rear wall of the cab, the sides below the cab, and for the rear end, all controlled by a switch on the door panel.

### Windows side

Tough, laminated glass prevents the glass from shattering in the event of an accident. The tough glass also insulates the cab against heat, cold and noise. An extra, laminated glass window can be fitted on the left- or right-hand side wall of the cab, adding light and a sense of space. Both side and door windows are available in single glass or laminated versions.

### Door window air deflector

For extra comfort, the door window air deflector allows the driver to keep the window partially open without having water or dirt entering the cab.

### Step cab side

For easy inspection of platform, tipper tray and similar, the day cab is equipped with a footstep on the left-hand outside. This option also includes a handle fitted to the roof.





**Beacon**

Mounted on a robust aluminium bar, the rotating beacon supplies efficient warning light. On cabs with a normal roof, the beacons can also be seen from behind.

**Roof rail**

The aluminium roof rail simplifies the fitting of an air deflector, roof rack and other extra equipment. The roof rails are fitted on either side of the cab roof and run from the front to the rear.

**External sun visor**

The sun visor prevents the driver from being exposed to direct sunlight, improving both visibility and comfort. Available with 2-5 integrated lamps.

**Cab tilting**

For convenient inspection and maintenance, the cab can be tilted with an electric pump located on the driver's side behind the front grille panel. The pump is activated by a switch on the instrument panel. Also available in a mechanical version.

**Scania XT range bumper**

With its 150-mm protrusion the XT range bumper provides effective protection of lower front components, head lamps and cab corners. The Scania XT vehicles are also compatible with front underrun protection in high or low position.

**Tail lamp protection**

The robust rear light protection is suitable for trucks operating in tough conditions.



## Exterior

### Close proximity mirror

Class V mirror that gives the driver visibility immediately below the passenger door. Available with manual or electrical operation, with or without heating. Visible glass dimensions 294×169 mm.

### Front view mirror

Mounted on the passenger side above the windscreen, the front view mirror allows the driver to see the area directly in front of the vehicle. Available with manual or electrical operation, with or without heating. Can also be used together with external sun visor.

### Spotlamp front grille panel

The cab is equipped with efficient spotlamps integrated in the upper front grille.

### Headlamp

To see and be seen is naturally a matter of safety, but well-designed lighting also shows character. The LED headlamps include main beam, dipped beam, daytime running lights and direction indicators with LED technology. Or choose an H7 lamp for main and dipped beam with an H21 lamp for direction indicators. Fog lamps, adapted to match either LED or H7 headlamps, secure maximum visibility in harsh weather conditions.

### Roof hatch

A roof hatch increases cab comfort by providing extra light, extra ventilation, and a feeling of increased space. Available in various designs, both manual and electric operation. Can be equipped with mosquito net. Roof hatch dimensions: 380–390×660 mm.

### Bumper

Protect fog lamps, headlamps and cab corners with the efficient front bumper. Choose between high, normal, or low position, and 0 or 40 mm protrusion.

### Second step in front

The lower front grille of the cab opens up to provide a sturdy platform to stand on when cleaning windscreen and lamps.



**Rear view mirrors**

Featuring optimal aerodynamic properties, all rear view mirrors are electrically adjustable and can be equipped with electrical heating for quick defrosting and demisting. The wide angle mirror, located above the rear view mirror, widens the field of vision and provides excellent visibility along the side of the vehicle.



**Fifth wheel working lamp**

Located on the left-hand side of the rear cab wall, the fifth wheel working lamp provides efficient lighting when connecting a trailer. Available with white or yellow light and activated by a switch on the door inner panel.

**Tail lamp**

The tail lamps and the reflective surface create a unique Scania look also from the rear. The tail lighting also increases safety, as following vehicles are quickly and clearly alerted. Available with LED technology or incandescent bulbs.







A close-up, low-angle shot of a dark, textured fabric, possibly a jacket or bag, featuring prominent orange stitching along a diagonal seam. The background is a dark, out-of-focus gradient.

**INTE**



**RIOR**

### Sun visor driver door

The sun visor is mounted on the door and shades the driver from sunlight through the side window. Available as blind type or foldable.

### Storage

The cab is equipped with enlarged and more easily accessible storage facilities above the doors and windscreen. The front upper storage space can also be used for holding a microwave oven or a coffee maker.

### Visibility

Features such as the new positioning of the driver seat, lowered side window, and lowered dashboard let you experience a whole new outlook. And visibility has turned from great to exceptional.

### Locking and alarm systems

The vehicle is equipped with security central locking and an additional internal door lock. When the alarm is activated, the cab is monitored by motion detectors and sensors on doors and hatches. The alarm system also includes a panic alarm activated either by the remote control or via the alarm button inside the cab.

### Immobiliser

If anyone tries to start the vehicle with the wrong key, the electronic immobiliser device cuts the fuel supply to the engine and the vehicle's starter motor will not run. An optional alco lock can also be installed to further enhance security.

### Safety systems

Complementing the rigorous safety setup, the cab has been equipped with extra airbags above the side doors, supplying maximum protection in roll-over accidents. In addition, there are advanced support systems to help the driver obtain maximum traffic safety, such as Advanced Emergency Braking and Lane Departure Warning systems.

### Internal lighting

The internal lighting can be set to suit every type of condition by providing efficient roof and boarding lamps, as well as reading lamps and subtle background lighting.

### Support systems

There are several support systems that helps the driver to maximise safety, fuel economy and comfort. One example is the adaptive cruise control that assists the driver in maintaining a constant gap to vehicles ahead and alerts the driver when the distance to the vehicle in front is too short. Even more sophisticated is the cruise control with active prediction; using GPS data, the system analyses the topography of up to 3 km of the road ahead, optimising fuel efficiency every second.

### Enhanced instrumentation

A larger display, improved graphics, and intuitive controls close at hand help you keep your full attention on the road ahead.

### Climate control

Whether you choose the automatic or premium level of climate control, you are always guaranteed a pleasant cab climate. Add the auxiliary cab heater and auxiliary resting cooler for extra comfort.

# YOUR VIEW FROM THE TOP

When designing the cab interior, we started out by carefully identifying the optimal driver position. The result is a cab that embodies maximum visibility, accessibility, and comfort. Thanks to a wide range of options, you can tailor the cab to suit your way of driving, working and living; experience a new level of driver satisfaction.

## USB ports

For easy communication with the infotainment system, a USB port and AUX input are placed either under the parking brake lever or centrally in the instrument panel. There are also USB charging ports on the passenger's side and in the rear wall.

## Fold-out table

The instrument panel on the passenger's side can be equipped with a fold-out table accommodating a smooth, prepared surface for working and eating. A practical version of the table can also be placed in the centre of the instrument panel.





## Interior

### Interior elegance to your taste

The options for choosing a customised interior design are practically limitless. To make your choice a little easier, our designers have put together a selection of interiors with perfectly matched colours, materials and finishes. There is also an additional matching inner panel covering the door mounting panel.

Choose between:

1. Brown/Light
2. Brown/Dark
3. Black/Dark
4. Black/Dark
5. V8
6. Wood



**Instrument panel finish**

The durable plastic panel with coordinated pattern and chrome parts creates a functional and appealing look. For even more high-quality finish, choose the soft instrument panel with additional storage options and textured rubber areas. Both the hard and soft instrument panel can be fitted for basic, standard, or exclusive options.









**Protective mats**

The loose, durable mats protect the cab floor, make cleaning easier, and complement a warm, comfortable interior. For even better living and working environment with lower noise levels, add an easy-to-clean mat for the engine tunnel. All mats are available in sturdy, solid rubber, black or dark sand textile (rubber underneath), or V8 design with red contrast seams and inlay of leather.

## Interior



### Instrument cluster

Large and distinct, with all the essential information easily monitored and controlled – the Scania instrument cluster displays information for the driver using both visual and audible signals. Choose between:

- Colour 4" screen
- Colour 7" screen



**Infotainment system**

The infotainment system provides easily overviewed information and entertainment content. Benefit from several features such as voice control, continuously updated map data, Bluetooth functions, and premium quality loud speakers. Many functions can be conveniently controlled via buttons in the steering wheel. Choose between two versions of infotainment systems:

- 2 DIN with 5" screen, Bluetooth
- 2 DIN with 7" screen, Bluetooth and navigation

**Remote control**

For easy control of the climate and infotainment systems. Comes with a handy attachment easily fastened to the cab wall.

**TV preparation**

The bracket is installed in the window recess behind the door on the driver's side. Maximum screen size is 26". The preparation includes a 12-volt socket, 3.5" AUX IN and an antenna connection.



### Driver seat

All Scania seats are designed to provide excellent comfort at all times and can be adjusted to individual needs, regardless of driver preferences or operating conditions. There is also a wide range of options, such as armrests, heating pads, and belt pretensioners. Choose between:

- Static
- Basic
- Medium A
- Medium B
- Premium

### Upholstery

Choose between several upholstery designs, all durable and easy to clean.

- Vinyl
- Woven
- Knitted and woven
- Velour black or sand
- Leather black or brown
- V8 leather black
- V8 woven + leather
- XT woven



### Passenger seat

Your passengers can travel just as comfortably as you can. Make your choice from the static version up to the turnable and reclining seat. There is also a foldable version that provides additional work surface and increases the amount of space in the cab. Available passenger seats:

- Static
- Basic
- Medium A
- Medium B
- Premium
- Foldable
- Reclining





**Steering wheel**

All steering wheel options give a steady grip and full control at your fingertips. The V8 and Leather versions have a flat base to enhance comfort and mobility. The steering wheels can be adjusted to ensure a comfortable position for all drivers.

- Exclusive leather
- Wood
- V8
- Standard
- Basic







### Storage

The rear storage facilities can be equipped to suit various needs. The storage under the lower bed can either consist of drawers or one large space with an optional insert tray. One of the drawers can also hold a refrigerator.

The rear upper space can be used for a roof shelf with plenty of storage room for personal items or working equipment. The shelf can be supplied with hatches for more secure storage, or fitted with a refrigerator.

There is also a new storage module for short cabs and day cabs. The module is attached onto a smart storage bar, an elegant aluminium rail stretching across the rear wall.

### Wall panels and headlining

The wall and side panels together with the headlining are available in vinyl or textile. The easy-to-clean vinyl panel is dirt-repellant and suitable for dirty environments, whereas the textile panel in sand colour adds a warm, elegant feeling and a sense of space. See the inspiring examples on pages 5, 7, 9, and 11.

### Beds

Depending on cab type, the upper bed compartment has room for a comfortable mattress of 600–800 mm. Add a safety net to keep stored items safely in place.















The lower bed is available as fixed 800 mm or extendable up to 1000 mm. Choose between mattress options Bonell with interconnected springs, body-adjusting foam, or Pocket spring for extra comfort. By adding a removable mattress pad you will protect the mattress, keep cool and have an optimised sleeping experience.

### Resting equipment









Also day cabs can accommodate opportunities for short periods of comfortable rest. The resting equipment consists of a bed that folds up against the rear wall, and a durable 7 cm foam rubber mattress. There is also a practical storage space under the bunk.

# SPECIFICATION OPTIONS

## CABS

	Sleeper cabs		Day cabs	
<b>S</b>	 High	 Normal		
<b>R</b>	 High	 Normal	 Low	
<b>G</b>	 High	 Normal	 Low	
<b>P</b>	 High	 Normal	 Low	
<b>L</b>				 High
<b>CREW CAB</b>		 Long CrewCab	 CrewCab	<p><b>Scania P-series CrewCab</b> Comfortable, safe and ergonomic for your crew.</p> <p><b>Engines</b> 220 to 500 hp</p>

Short cabs

			<p><b>Scania S-series</b> Unique spaciousness, flat floor and extended storage. The obvious choice for the longest transports.</p> <p><b>Engines</b> 370 to 730 hp</p>
 Normal	 Low		<p><b>Scania R-series</b> Pure premium in every detail. Comfort and prestige for demanding routes.</p> <p><b>Engines</b> 280 to 730 hp</p>
 Normal	 Low	 Low	<p><b>Scania G-series</b> Robust and well-equipped. Mid-size cab suitable for a wide range of applications.</p> <p><b>Engines</b> 280 to 500 hp</p>
 Normal	 Low	 Low	<p><b>Scania P-series</b> Lightweight, economic and comfortable. Compact dimensions paired with full size quality and performance.</p> <p><b>Engines</b> 220 to 500 hp</p>
 Normal	 Low		<p><b>Scania L-series</b> Tailored for city operations. Low boarding step, great visibility, safe and easy access.</p> <p><b>Engines</b> 280 to 360 hp</p>

**Scania configurator**

There are excellent opportunities for you to put a stamp on your vehicle and customise your Scania – regardless of your application. Or taste, for that matter. Go to the Scania configurator on [scania.com](http://scania.com) and see what options are available on your market.



## CAB DIMENSIONS

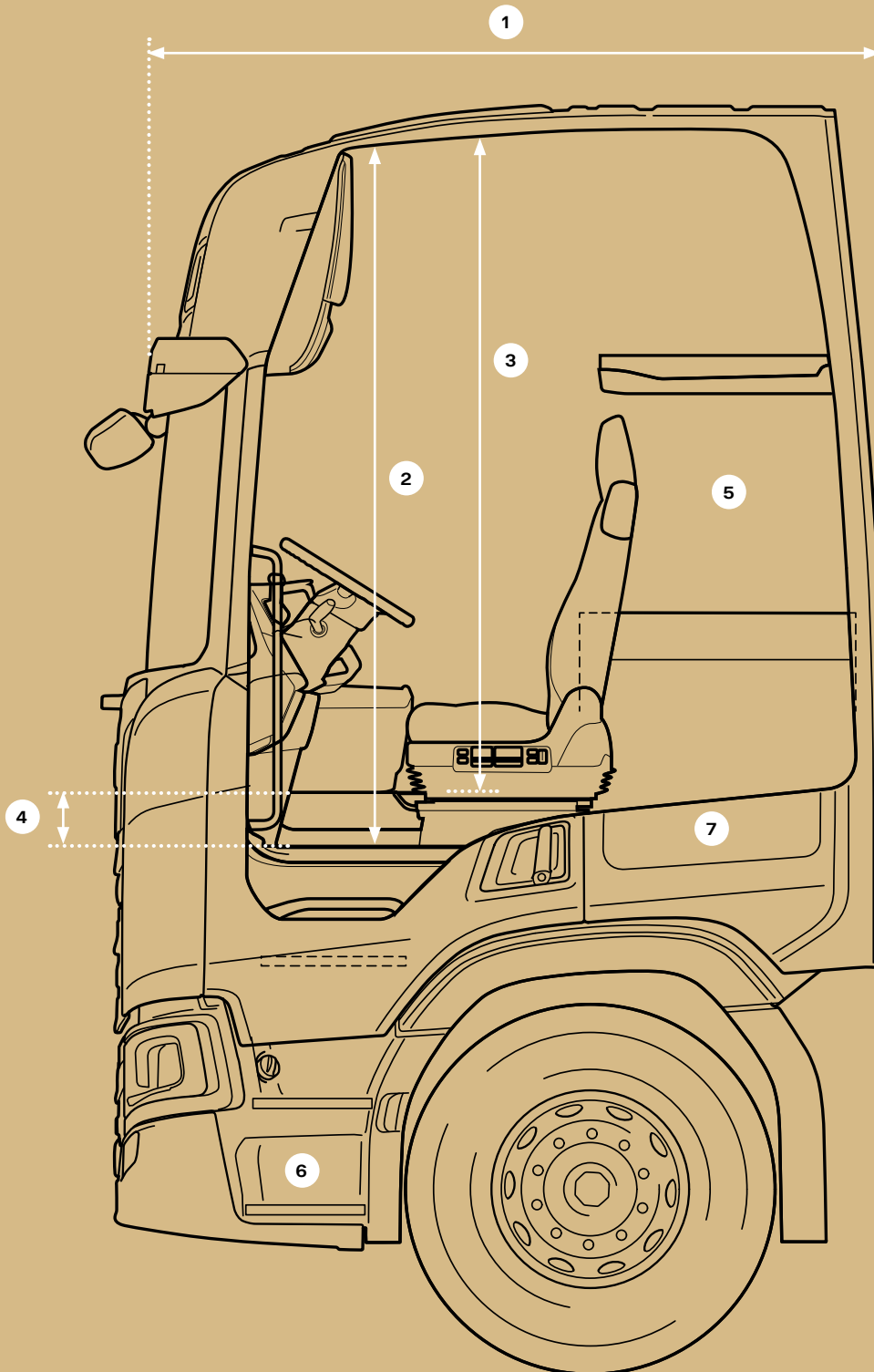

- 1. Overall length
- 2. Floor-to-roof, footwell
- 3. Floor-to-roof, cab center
- 4. Floor height, cab center
- 5. Bed option
- 6. Steps
- 7. External storage

Sleeper cabs
S high
R high
G high
P high
S normal
R normal
G normal
P normal
R low
G low
P low
Day cabs
L high
R normal
G normal
P normal
L normal
R low
G low
P low
L low
Short cabs
G low
P low
Crew cabs
Long CrewCab
CrewCab

1	2	3	4	5	6	7
2,280 mm	2,070 mm	2,070 mm	Flat floor	2 <sup>1)</sup>	4	161 + 161 litre *
2,280 mm	2,070 mm	1,915 mm	155 mm	2 <sup>1)</sup>	3	187 + 187 litre
2,280 mm	2,030 mm	1,695 mm	335 mm	2 <sup>2)</sup>	3	123 + 123 litre
2,280 mm	2,030 mm	1,590 mm	440 mm	1	2	168 + 168 litre
2,280 mm	1,850 mm	1,850 mm	Flat floor	2 <sup>3)</sup>	4	161 + 161 litre *
2,280 mm	1,850 mm	1,695 mm	155 mm	2 <sup>3)</sup>	3	187 + 187 litre
2,280 mm	1,800 mm	1,465 mm	335 mm	2 <sup>3)</sup>	3	123 + 123 litre
2,280 mm	1,800 mm	1,360 mm	440 mm	1	2	168 + 168 litre
2,280 mm	1,500 mm	1,345 mm	155 mm	1	3	187 + 187 litre
2,280 mm	1,500 mm	1,165 mm	335 mm	1	3	123 + 123 litre
2,280 mm	1,500 mm	1,060 mm	440 mm	1	2	168 + 168 litre
2,280 mm	2,030 mm	1,430 mm	600 mm *	–	1 or 2	–
2,010 mm	1,850 mm	1,695 mm	155 mm	–	3	101 + 101 litre
2,010 mm	1,800 mm	1,465 mm	335 mm	–	3	63 + 63 litre
2,010 mm	1,800 mm	1,360 mm	440 mm	–	2	89 + 89 litre
2,280 mm	1,800 mm	1,200 mm	600 mm *	–	1 or 2	–
2,010 mm	1,500 mm	1,345 mm	155 mm	–	3	101 + 101 litre
2,010 mm	1,500 mm	1,165 mm	335 mm	–	3	63 + 63 litre
2,010 mm	1,500 mm	1,060 mm	440 mm	–	2	89 + 89 litre
2,280 mm	1,500 mm	900 mm	600 mm *	–	1 or 2	–
1,730 mm	1,500 mm	1,165 mm	335 mm	–	2	–
1,730 mm	1,500 mm	1,060 mm	440 mm	–	2	–
3,545 mm	1,500 mm	1,060 mm	440 mm	–	2	–
3,265 mm	1,500 mm	1,060 mm	440 mm	–	2	–

**4 Floor height**

\* Cross cab access in front of engine tunnel.

**5 Beds**

Lower bed: width <1,000 mm, length 2,175 mm.

- <sup>1)</sup> Upper bed (optional): width 800 mm, length 1,940 mm.
- <sup>2)</sup> Upper bed (optional): width 700 mm, length 1,940 mm.
- <sup>3)</sup> Upper bed (optional): width 600 mm, length 1,940 mm.

Choose between mattress options Bonell with interconnected springs, body-adjusting foam, or Pocket spring.

**7 External storage**

Placed behind the door on both driver's and passenger's side, the external storage compartment is equipped with lighting and has access from both the outside and inside of the cab.

\* The S-cab also features an extra compartment for gloves, boots, etc. placed below the external storage mentioned above. The extra compartment is accessible from the outside and measures 661×108/180 mm.

# CHASSIS

## Axle configuration

The new Scania tractors and rigids are available in a variety of axle configurations. Contact your Scania dealer to find the best solution for your needs.

### Tractors

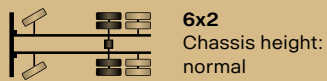
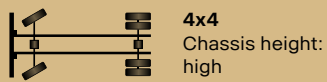
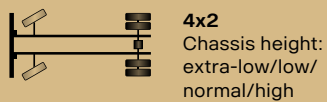

### Rigids

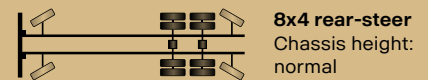
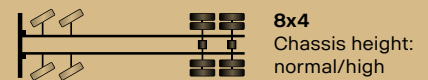
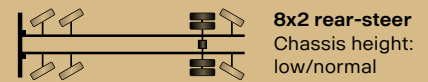
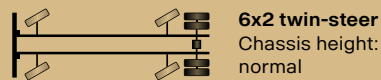
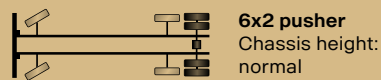
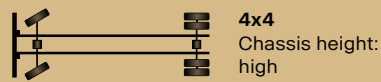

## Fifth-wheel coupling

You can get your Scania tractor with a range of ready-mounted fifth wheels. In addition to the traditional fixed or sliding fifth wheels, there is also the unique Scania direct-mounted fifth wheels option. This option gives an increase in payload by approximately 90 kg. The Scania direct-mounted fifth wheel is available for both the two- and four-spring air suspension.



# ENGINES AND TRANSMISSION

## Euro 6 engines

Swept volume	Maximum power	Maximum torque	Emission control
<b>5 inline</b>			
9-litre *	280 hp (206 kW) at 1,900 r/min	1,400 Nm (1,000–1,350 r/min)	SCR
9-litre gas	280 hp (206 kW) at 1,900 r/min	1,350 Nm (1,000–1,400 r/min)	EGR
9-litre *	320 hp (235 kW) at 1,900 r/min	1,600 Nm (1,050–1,350 r/min)	SCR
9-litre gas	340 hp (250 kW) at 1,900 r/min	1,600 Nm (1,100–1,400 r/min)	EGR
9-litre *	360 hp (265 kW) at 1,900 r/min	1,700 Nm (1,050–1,350 r/min)	SCR
<b>6 inline</b>			
7-litre **	220 hp (164 kW) at 1,900 r/min	1,000 Nm (1,050–1,500 r/min)	SCR
7-litre **	250 hp (184 kW) at 1,900 r/min	1,100 Nm (1,050–1,550 r/min)	SCR
7-litre **	280 hp (206 kW) at 1,900 r/min	1,200 Nm (1,050–1,600 r/min)	SCR
13-litre *	370 hp (272 kW) at 1,900 r/min	1,900 Nm (1,000–1,300 r/min)	SCR
13-litre *	410 hp (302 kW) at 1,900 r/min	2,150 Nm (1,000–1,300 r/min)	SCR
13-litre gas	410 hp (302 kW) at 1,900 r/min	2,000 Nm (1,100–1,400 r/min)	EGR
13-litre *	450 hp (331 kW) at 1,900 r/min	2,350 Nm (1,000–1,300 r/min)	SCR
13-litre *	500 hp (368 kW) at 1,900 r/min	2,550 Nm (1,000–1,300 r/min)	SCR
<b>V8</b>			
16-litre **	520 hp (382 kW) at 1,900 r/min	2,700 Nm (1,000–1,300 r/min)	SCR
16-litre **	580 hp (427 kW) at 1,900 r/min	3,000 Nm (950–1,350 r/min)	SCR
16-litre **	650 hp (479 kW) at 1,900 r/min	3,300 Nm (950–1,350 r/min)	SCR
16-litre **	730 hp (537 kW) at 1,900 r/min	3,500 Nm (1,000–1,400 r/min)	SCR, EGR

\* Also available for biodiesel and HVO      \*\* Also available for HVO

## Gearboxes

Gears	Type	Engines	Options
<b>Range-change gearboxes</b>			
8 gears	Light-duty gearbox	Up to 2,100 Nm	Opticruise, Retarder
8+1 gears	Heavy-duty gearbox with crawler	Up to 2,400 Nm	Retarder
<b>Range-splitter gearboxes</b>			
12 gears	Premium gearbox	Up to 2,350 Nm	Opticruise, Retarder
12+2 gears	Premium gearbox with two crawlers	Up to 2,700 Nm	Opticruise, Retarder
12+2 gears	Premium overdrive gearbox with two crawlers	Up to 3,500 Nm	Opticruise, Retarder
<b>Automatic gearboxes</b>			
Automatic gearboxes are available together with most of the 5- and 6-cylinder engines			

## Power take-offs

There are many ways to tap into the power of your Scania. Our PTO options include gearbox-driven (clutch dependent), flywheel-driven (clutch independent) and engine-driven solutions.

