



LOW FLOOR

SCANIA C-CHASSIS

FOR URBAN TRANSPORT OPERATIONS



SCANIA



DESIGNED FOR SUSTAINABLE AND EFFICIENT MOBILITY

Based on more than a century of engineering experience, the new generation of Scania buses has been developed to meet the demands of today's and tomorrow's cities; energy efficient, available in a wide range of powertrains and offering the latest technology in everything from safety systems to reduced emission and noise levels. And through excellent uptime, fuel economy and the possibility of high passenger capacity, the new Scania buses allow sustainable mobility to go hand-in-hand with operating economy.

For a better city environment

Having the right vehicle for the operation and using it efficiently is the best way to minimise environmental impact. Scania offers fully electric buses and engines running on all commercially viable renewable fuels – biodiesel/FAME, HVO and biogas powertrains, in order to meet the requirements of all urban operations. Through high quality vehicles and innovative technical solutions, maintenance, and a range of driver services, we address fuel efficiency from all angles, helping operators to reduce emissions and fuel costs.

To create a positive passenger experience, Scania buses have independent front suspension that makes the ride more comfortable and a highly efficient climate system that minimises energy consumption and can handle just about all types of climates. And with fully electric powertrain options, Scania can provide buses that that are almost silent in operation.

To help prevent accidents and create a safer city environment, Scania buses have built-in state-of-the-art safety systems and features. These help the driver by increasing their awareness of other road users, and even help to control the vehicle when required.

Energy efficiency lowers operating cost

Public transport operators know the importance of keeping operating costs to a minimum, and fuel consumption is one of the main contributors to cost. An energy efficient powertrain can therefore offer significant savings in fuel. Scania develops and offers highly energy efficient powertrains, both traditional and electrified. Compared to previous models, the new generation of Scania buses can potentially save up to 21% in fuel and emissions, without compromising on performance. This is achieved through a number of factors, with the most significant savings coming from improved engine and gearbox efficiency, altered engine position, weight reductions and the addition of a start/stop function. Beyond the powertrain, driving style has a major impact on fuel consumption. The drivability of Scania's vehicles and our driver assistance systems, as well as our driver services, can potentially contribute to further fuel savings of up to 10%.



Ensuring availability through reliable solutions

Reducing vehicle downtime and increasing utilisation is essential to making urban operations cost-efficient. Our buses are built on proven technology and components, resulting in chassis and powertrains that are dependable, durable, and robust. That reliability is the key to minimising time in the workshop and maximising utilisation of the vehicle.

Our buses are designed and constructed to make sure that sensitive and expensive components are protected in the event of a collision. Limiting damage and avoiding deformation of components such as the steering, aftertreatment system, and batteries is critical for minimising costs, as well as complex and time-consuming repairs. Additionally, Scania buses are designed to facilitate maintenance and to make it as efficient as possible. Here, Scania offers professional workshop services with excellent parts availability to secure maximum uptime.

A first-class driver area

A bus operating in urban traffic is constantly exposed to the risk of external damage and the work environment for the driver can be very demanding. A quality driver environment can therefore play a crucial role in reducing the risk of collisions, downtime, sick-leave, and improving employee retention. The driver area in Scania buses is simply first-class and can even be said to be industry leading. A great turning radius, good visibility, and an overall well-balanced vehicle makes for excellent driveability, while advanced driver assistance systems give the driver good control of the vehicle through improved assisted handling, steering and braking. This increases safety and helps minimise accidents and the associated costs. Due to the demanding work environment, operators also face challenges when it comes to sick leave and employee retention; that's why we've designed the best possible work environment for drivers in terms of ergonomics, reachability, climate control, safety features and an overall quality feel.

Powertrains

The low floor Scania C-chassis offers a wide range of energy efficient and reliable powertrains optimised for inner-city traffic.

Fully electric	Output	Torque	Energy consumption	
Electric motor	300 kW peak 250 kW continuous (R85)	2100 Nm (peak)	0.75–1.5 kWh/km	
Number of high-voltage battery packs: 8 or 10 battery packs Battery capacity: 254 kWh or 330 kWh				
Combustion (Euro 6)	Output	Torque	Emissions control	Fuel options
7-litre	280 hp (206 kW) at 1900 r/min	1200 Nm (1050–1600 r/min)	SCR	Biodiesel, HVO, diesel
9-litre	320 hp (235 kW) at 1900 r/min	1600 Nm (1050–1400 r/min)	SCR	Biodiesel, HVO, diesel
Fuel capacity (usable volumes): 140–360 litres				
9-litre	280 hp (206 kW) at 1900 r/min	1350 Nm (1000–1400 r/min)	EGR	Biogas, natural gas
9-litre	340 hp (250 kW) at 1900 r/min	1600 Nm (1100–1400 r/min)	EGR	Biogas, natural gas
Fuel capacity: 1260–1875 litres				

Gearboxes

6-speed fully automatic gearbox (ZF EcoLife 2)

- Start/stop function, acceleration control

2-speed gearbox for E-machine

Axles

The low floor Scania C-chassis is available in several variants, enabling it to meet different operational requirements.

2-axles, 4x2

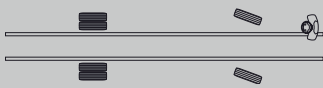

Independent front suspension or rigid front axle.

3-axles (articulated), 6x2/2

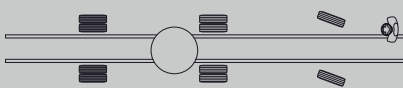

Independent front suspension or rigid front axle.

Floor level

The low entry point and flat floor throughout the bus increases accessibility for all passengers, including wheelchair users and children in strollers. In combination with the wide aisle, these features also contribute to efficient passenger flow.



PRODUCT DESIGN FEATURES

The low floor Scania C-chassis meets the needs of operators on every continent. With total design and production control over chassis and powertrain, Scania delivers unrivalled reliability, durability and performance.

Driver area

The driver area has a completely new design with improved ergonomics, safety, comfort, and driveability.

- Excellent ergonomics and reachability – pedal placement, leg space, driver height settings, all-angle step-less seat adjustments, adjustable instrument panel and flexible switch placement due to CAN-functionality.
- Increased safety – electro-pneumatic parking brakes.
- Excellent drivability – great turning radius, advanced driver assistance systems, and improved assisted handling, steering and braking.
- Enhanced climate system – improved climate system with better airflow.

Electric system

The new power supply architecture comes with improved electronic control units (ECUs) and functions that improve performance and facilitate diagnostics for repair and maintenance. It also enables new functionality within ADAS, e-mobility and autonomous transport systems.

Fuel tanks

New front fuel tanks available in several volume options suitable for urban/suburban operations, 140–360 litres (usable volumes). Also the shape of the fuel tanks is optimised for the inner layout to enable mounting of seats closer to the wheelhouses.

Articulation control

Scania buses features an industry-leading control system for its articulated variants. It prevents instability and jack-knifing by using wheelspin control, traction control, articulation damping system and patented sway control. This facilitates handling, manoeuvrability, and safe driving in slippery conditions and during lane changes at high speeds.

Front suspension technology

Without compromising on passenger capacity, the new independent front suspension offers excellent passenger comfort and enables a wider aisle (900 mm). This results in new layout possibilities, increased passenger flow, space and accessibility.

Chassis frame construction

The strengthened front axle, in combination with the ability to now use wider tyres, means that load capacity is increased from 7.1 to 8.2 tonnes. This allows higher passenger capacity. It also enables optimised weight distribution between the front and rear axles – especially important for gas and electric vehicles. Additionally, chassis weight has been reduced by 5% (-300 kg) without compromising robustness, contributing to lower fuel consumption.



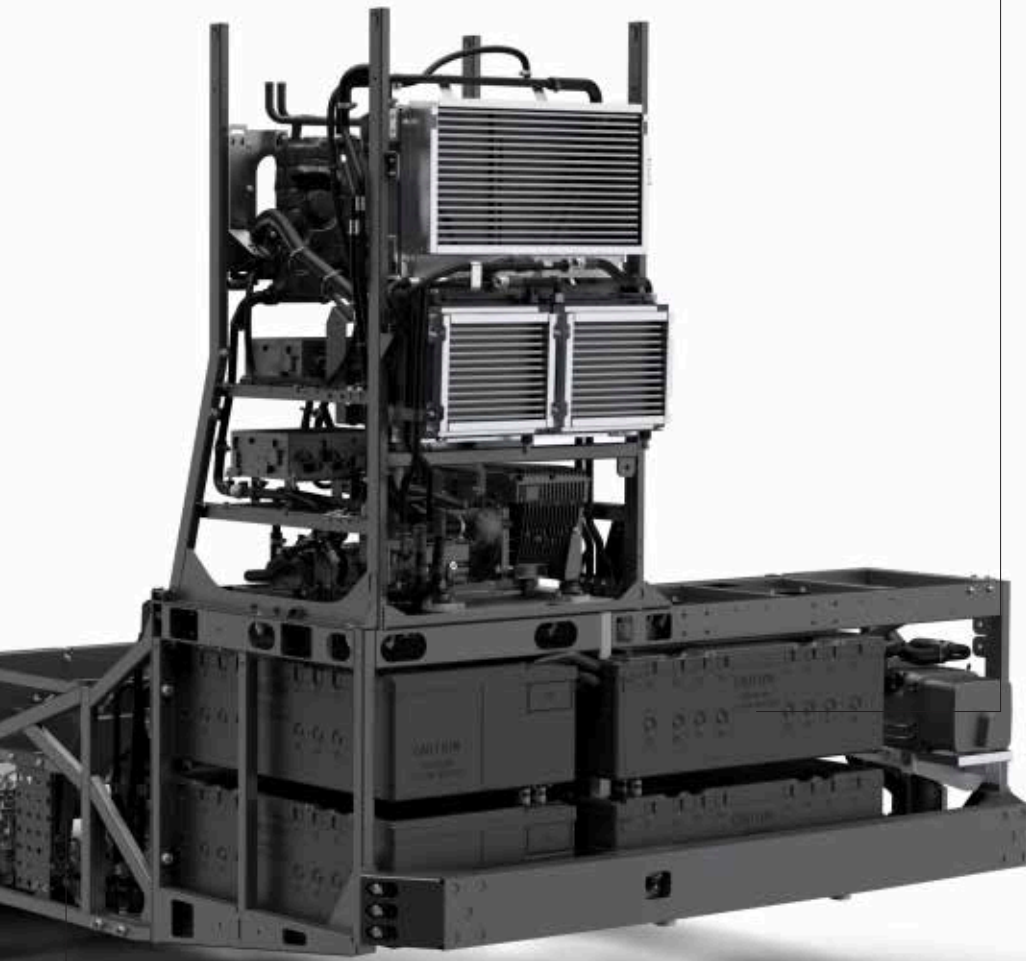

Battery packs

The battery packs are placed on the roof and in the rear, creating a well-balanced bus with excellent driveability and ride comfort.

Battery temperature control

Battery pack temperature is controlled by a closed water cooling system. In very cold or very hot ambient temperatures, the water cooling is assisted by an electric heater or a A/C cooling respectively.

The assisting A/C is separated from the passenger and driver A/C, and integrated in the battery cooling circuit. These solutions enable propulsion without power limitation in temperatures from -35°C to $+40^{\circ}$, for all conditions up to 16% slopes, without compromising vehicle speed.

Powertrain technology

The highly dependable, durable, and robust powertrains enable fuel savings of up to 21%, achieved through a number of factors such as;

- Engine (-6%)
- Changed driveline position (-3%)
- Gearbox (-3%)
- Weight (-3%)
- Start/stop function (-6%)

Safety features

A range of functions support the driver in demanding urban environments.

- Electro pneumatic parking brake – locks the brakes until acceleration is activated, thereby preventing unintentional vehicle motion.
- Acceleration control - assists the driver to accelerate more smoothly energy efficient

and comfortable. Vulnerable road user collision warning – detects cyclist and pedestrians close to the vehicle.

- Blind spot warning – detects other vehicles located in the driver's blind spot area.
- Underrun protection – rigid beams in the rear protect passengers and sensitive components.

7-litre, 280 hp
Biodiesel, HVO, diesel

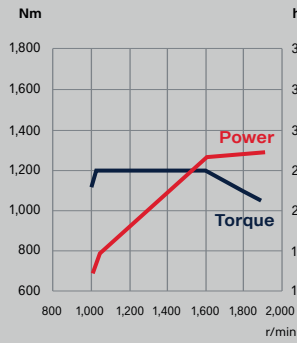

9-litre, 320 hp
Biodiesel, HVO, diesel

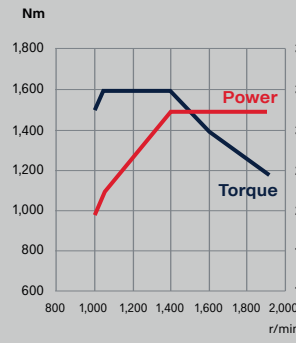

9-litre, 280 hp
Biogas, natural gas

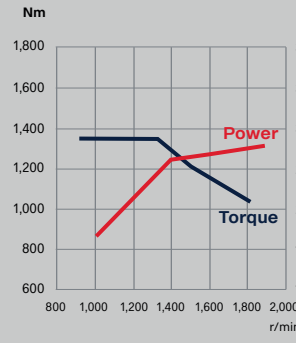

9-litre, 340 hp
Biogas, natural gas

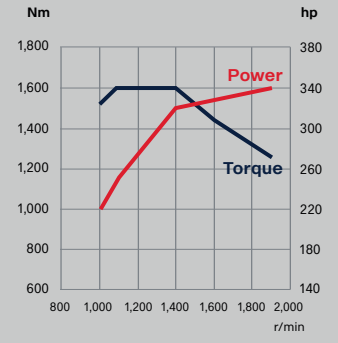

Powertrain – Fully electric

Electric motor:

300 kW (peak), torque 2100 Nm
250 kW (continuous)

Gearbox: 2-speed to optimise energy consumption

Battery capacity: 254 kWh or 330 kWh, Lithium-Ion (NMC)
8 or 10 battery packs placed 4 in rear and 4 or 6 on the roof.

Charging options:

In-route (pantograph charging): Up to 300 kW
Depot (CCS type 2): DC up to 150 kW

Powertrain – Combustion, Euro 6

Biodiesel, HVO, diesel:

7-litre 280 hp (206 kW), torque 1200 Nm
9-litre 320 hp (235 kW), torque 1600 Nm

Fuel capacity (usable volumes): 140–360 litres

Biogas, natural gas:

9-litre 280 hp (206 kW), torque 1350 Nm
9-litre 340 hp (250 kW), torque 1600 Nm

Fuel capacity: 1260–1875 litres

Gearbox:

6-speed fully automatic with acceleration control

Axle and suspension

Configurations: 2-axle, 3-axle articulated

Front axle:

Independent wheel suspension or rigid axle
Max. load capacity 8.2 tonnes, articulated 8.0 tonnes

Rear axle:

Rigid axle, driven
Max. load capacity 12 tonnes

Centre axle (articulated):

Rigid axle
Max. load capacity 11.5 tonnes

Full air suspension with electronic level control system (ELC)
Total raising or lowering of chassis height in the front or the whole side

Wheel

Tyre size (front):

275/70, 275/80, 295/80, 315/60, 315/70

Tyre size (rear):

275/70, 275/80, 295/80
Aluminum or steel rims

Electrical system

150, 180, 210 or 230 Ah or dual battery system, 24 V
Alternator 150, 180, 2x150 or 2x180 A

Brakes

Disc brakes, electronic brake system (EBS), anti-lock brake system (ABS), traction control (TC), bus stop brake, hill-hold, pad wear indicator, pipes manufactured from either rust-protected steel or high impact synthetics, separate air tanks for each circuit, exhaust brake with automatic control

Support system

Scania Driver Support, electropneumatic parking brake, adaptive cruise control (ACC), vulnerable road user collision warning, blind spot warning



SERVICE OFFERING

Our offering consists of a number of services for minimising emissions, increasing safety, and improving operating economy, focusing on areas like fuel efficiency and uptime. These services allow us to provide solutions to each operators' individual challenges and needs.

Scania's data services generates insight and create business value through anything from position and speed to performance and driving style. Scania's data API's comply with the rFSM standards 1.x and 2.x.

Driver services

Enables drivers to drive safer and more efficient, and can reduce the need for maintenance.

Scania Driver Training

Combines theory and practice, covering topics such as safe and efficient driving, especially important when it comes to electric vehicles, not only to save energy but even regenerate energy by optimal driving. Handles also other aspects of professional driving, always with a focus on profitability, fuel economy and reduced emissions.

Scania Driver Evaluation

An on-board device that assesses the driving style by comparing it to that of drivers operating in similar conditions. The result, which can be used to achieve long term improvements, is visible in the Scania Fleet Management Portal and Scania Fleet App.

Tachograph services

The fleet is monitored via the tachograph portal, facilitating compliance with regulations regarding driving and working time. A tool that provides in-depth insights into driver activities and vehicle use, thus helping operators maximise uptime, comply with laws and regulations and meet health and safety requirements for drivers.

Fleet management services

The data collected on board the buses provides valuable insight into driving styles, productivity and economy. This level of tracking and diagnostics can bring significant benefits in terms of increased uptime, improved safety and reduced operating costs. Through the Scania Fleet Management Portal and the Scania Fleet App, operators can gain access to valuable insights and reap the benefits.

Scania Zone

A position-based system for real-time vehicle adjustments in pre-defined zones. It allows operators to ensure that each vehicle stays within the set speed limits, increasing city safety and lowering fuel consumption. Scania Zone is an optional add-on in Scania's fleet management system.

Repair and maintenance services

Having access to professional workshops and quality spare parts is key to keeping the vehicles in prime condition. Scania offers a range of repair and maintenance services:

Scania Flexible Maintenance

Uses real-time vehicle data to produce maintenance plans tailored to each vehicle's actual operation, meaning no underserving and no overserving. This is done by continually monitoring and analysing operational data to ensure maximum uptime and schedule maintenance customised to the operations, thus increasing productivity and decreasing disruptions.

Scania Fleet Care

The fleet operator receives a dedicated Fleet Manager from Scania equipped with advanced tools and systems, to optimise maintenance and prevent breakdowns based on operational data and vehicle data analysis.

Customer workshop services

A tailored collaboration service designed to facilitate for the operator by streamlining and quality assuring the workshop and workshop processes to meet Scania standards.

Financial services

Flexible financing and insurance solutions that suit the operational needs, tailored to provide predictable costs and manageable risks – over the entire lifecycle of the vehicles.

Scania Financing

Tailored solutions for financing an expansion or a fleet renewal. Handled with professional knowledge of financial of the transport business and optimised for the local tax and legal environment.

Scania Insurance

Tailored solutions that, together with claims support service and Scania Assistance, will help get the vehicle back on the road quicker, safeguarding uptime – and peace of mind.