



DC13 073A. 438-487 kW (503-553 kVA)

EU Stage II, China Phase II and CPCB-I*



The engines for power generation from Scania are based on a robust design with a strength optimised cylinder block containing wet cylinder liners that can easily be exchanged. Individual cylinder heads with 4 valves per cylinder promotes repairability and fuel economy.

The engine is equipped with a Scania developed Engine Management System, EMS, in order to ensure the control of all aspects related to engine performance.

The injection system is based on electronically controlled unit injectors that gives low exhaust emissions with good fuel economy and a high torque. The engine can be fitted with many accessories such as air cleaners, radiators and PTOs in order to suit a variety of installations.

	Engine speed (rpm)			
	1500 rpm (50 Hz)		1800 rpm (60 Hz)	
	PRP	ESP	PRP	ESP
Gross power (kW)	438	480	445	487
Gross power (kVA)	503	553	503	553
Spec fuel consumption. Full load (g/kWh)	194	198	196	200
Spec fuel consumption. 3/4 load (g/kWh)	201	203	205	205
Spec fuel consumption. 1/2 load (g/kWh)	198	198	206	206
Heat rejection to coolant (kW)	130	158	136	162

PRP – Prime power: For continuous operation at varying load. Max mean load factor of 70% of rated power over 24 h of operation. 1 hour/12 hours period of accumulated peak overload to 110%.

ESP – Stand-by power: For operation under normal varying load during a power outage. Not overloadable. Max mean load factor of 70% of rated power over 24 h of operation. Not for applications intended for more than 200 h/year.

*) CPCB-I: Mass Emission & Smoke Norms for Genset Diesel Engine, up to 800 kW (for India). Only valid for PRP.

Standard equipment

- Scania Engine Management System, EMS
- Unit injectors, PDE
- Turbocharger
- Fuel filter and extra pre-filter with water separator
- Oil filter, full flow
- Centrifugal oil cleaner
- Oil cooler, integrated in block
- Oil filler, in valve cover
- Deep front oil sump
- Oil dipstick, in block
- Magnetic drain plug for oil draining
- Starter, 1-pole 6.0 kW
- Alternator, 1-pole 100A
- Flywheel, SAE 14
- Silumin flywheel housing, SAE 1 flange
- Front-mounted engine brackets
- Open crankcase ventilation
- Operator's manual

Optional equipment

- Cooling package
- Fans
- Side-mounted PTO
- Exhaust connections
- Instrument panel
- Engine heater
- Stiff rubber engine suspension
- Air cleaner
- Closed crankcase ventilation
- Studs in flywheel housing
- Low coolant level reaction
- Fine tune potentiometer
- Ramp start delay
- Ramp up rate

This specification may be revised without notice.

DC13 073A. 438-487 kW (503-553 kVA)

EU Stage II, China Phase II and CPCB-I*

Engine description

No of cylinders	6 in-line
Working principle	4-stroke
Firing order	1 - 5 - 3 - 6 - 2 - 4
Displacement	12.7 litres
Bore x stroke	130 x 160 mm
Compression ratio	16.3:1
Weight	1050 kg (excl oil and coolant)
Piston speed at 1500 rpm	8.0 m/s
Piston speed at 1800 rpm	9.6 m/s
Camshaft	High position alloy steel
Pistons	Steel pistons
Connection rods	I-section press forgings of alloy steel
Crankshaft	Alloy steel with hardened and polished bearing surfaces
Oil capacity	30-36 dm ³ (standard oil sump)
Electrical system	1-pole 24V

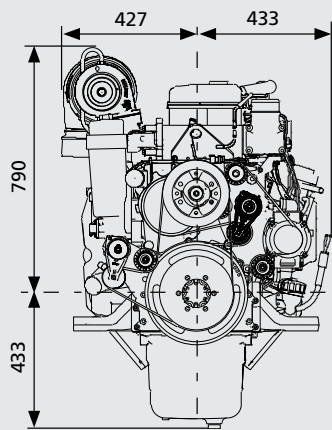
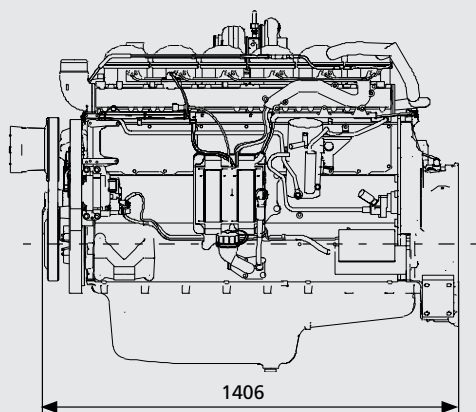

All dimensions in mm



SE 151 87 Södertälje, Sweden
 Telephone +46 8 553 810 00
 Telefax +46 8 553 829 93
 www.scania.com
 engines@scania.com