

SCANIA POWER GENERATION NATURAL GAS ENGINE: FUEL OPTIMIZED

16-LITRE ENGINE



Engine description

OC16 071A. 333-372 kW (364-409 kVA)

Engine speed	1,500/1,800 rpm
Emission compliance	Fuel optimized
Rating	PRP
No of cylinders	90° V8
Working principle	4-stroke
Displacement	16.4 litres
Weight	1,352 kg (excluding oil, coolant and cooling package)
Oil capacity	40-48 litres (standard oil sump)
Electrical system	1-pole 24 V DC

The Scania lean-burn gas engines work according to the Otto principle, with spark ignition. The engine is equipped with a low pressure gas system, and air-to air charge air cooler for high efficiency and no need for compressed gas.

Thanks to Scania's modular system, the gas-fuelled engine shares many components with the diesel V8 engine, making the engines both efficient and simple to maintain and repair. The engine can be handled by Scania's standard diagnostic tool.

Our gas engines produce best in class specific power, and all are characterised by high performance, excellent fuel efficiency, low carbon emissions and low noise levels. The engine can suit a variety of installations, but the main purpose is COP for electric production.

Standard equipment

- Engine Management System, OCE1 EMS
- Zero pressure gas feed regulator
- Gas mixer
- Turbocharger
- Oil filter, full flow
- Centrifugal oil cleaner
- Oil cooler, integrated in cylinder block
- Oil filler, in cylinder block
- Deep front oil sump
- Oil dipstick, in cylinder block
- Magnetic drain plug for oil draining
- Starter motor, 1-pole 7.0 kW
- Alternator, 1-pole 100 A
- Flywheel, SAE 14
- Silumin flywheel housing, SAE 1 flange
- Front-mounted engine suspension
- Air cleaner, mounted on engine
- Pusher fan, Ø 965 mm
- Cooling package and radiator 1.5 m² including fan cover, expansion tank and fan and belt protection
- Coolant level monitor
- Closed crankcase ventilation

This specification may be revised without notice.

Dimensions

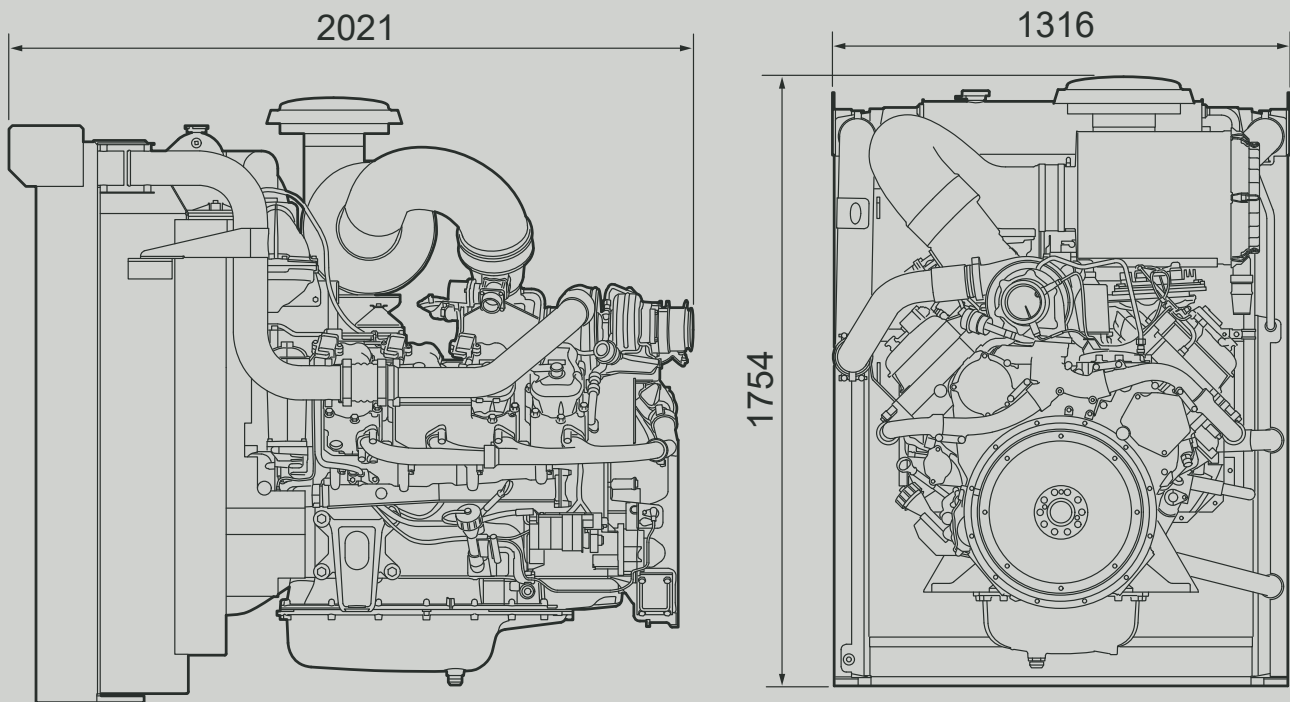

Edition 04

Technical data

	1500 rpm (50 Hz)		1800 rpm (60 Hz)		Unit
	PRP	COP	PRP	COP	
Gross power	333	330	372	350	kW
	364	360	409	383	kVA
Gross torque	2,120	2,101	1,974	1,857	Nm
Mechanical efficiency	40	40	39	39	%
Fuel consumption at full load	193	194	200	201	g/kWh
Heat rejection					
to coolant	177	176	201	195	kW
to exhaust gas	230	228	287	271	kW
to charge air	52	51	55	49	kW
to surrounding air	41	33	48	36	kW
Air consumption	27	27	31	29	kg/min
Air temperature					
upstream of charge air cooler	157	156	147	140	°C
downstream of charge air cooler	43	42	42	40	°C
Pressure in intake manifold	1.3	1.3	1.2	1.1	bar
Pressure drop in charge air cooler	0.2	0.2	0.2	0.2	bar
Exhaust flow	28	28	32	30	kg/min
Exhaust temperature	473	473	512	509	°C
Step load performance (according to class G2)	28		33		%
	95		121		kW

PRP - Prime power: For continuous operation at varying load. Max mean load factor of 70% of rated power over 24 hours of operation.

COP - Continuous power: For continuous operation at a constant load for an unlimited number of hours per year.