

SCANIA INDUSTRIAL ENGINE: EU STAGE V

16-LITRE ENGINE

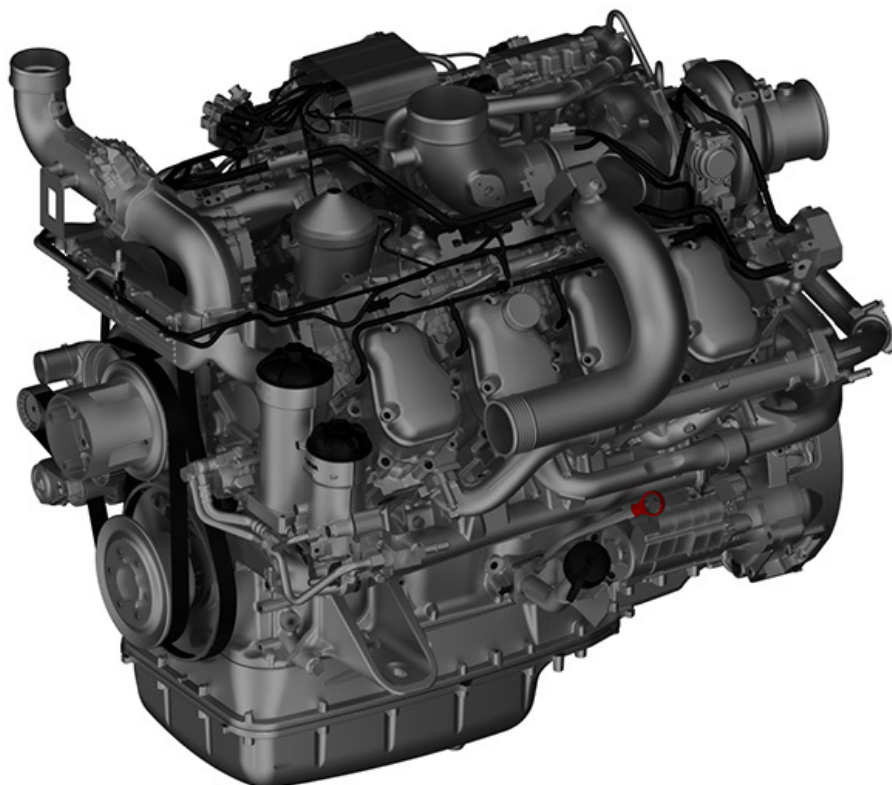

Engine description

DC16 317A. 405 kW

Engine speed	2,100 rpm
Emission compliance	EU Stage V
Rating	ICFN
No of cylinders	90° V8
Working principle	4-stroke
Displacement	16.4 litres
Weight	1,381 kg (excluding oil and coolant)
Oil capacity	40-48 litres (standard oil sump)
Electrical system	1-pole 24 V DC

Scania's industrial engines for emission level EU Stage V are based on a robust design for superior operating economy and reliability. With their modular design, the engines offer easy installation for the producer of the equipment as well as easy access to daily checks and service for the operator. The engines can be fitted with many accessories such as air cleaners, PTOs, exhaust fittings and flywheels, to suit a variety of installations.

Scania's EU Stage V engines are equipped with a Scania developed extra high pressure fuel injection system based on common rail technology, and a turbocharger optimized for operation in combination with the exhaust gas aftertreatment system. Together with Scania's Engine Management System, the result is an engine that fulfils the strictest exhaust emission requirements, with low fuel consumption and a high torque.

Standard equipment

- Scania Engine Management System, EMS
- Extra high pressure fuel injection system, XPI
- Variable geometry turbocharger (VGT)
- Saver ring in cylinder liner
- Fuel filter and extra pre-filter with water separator
- Oil filter, full flow
- Centrifugal oil cleaner
- Oil cooler, integrated in cylinder block
- Oil filler, in valve cover
- Oil dipstick, in cylinder block
- Deep front oil sump
- Magnetic drain plug for oil draining
- Starter motor, 1-pole, 7.0 kW
- Alternator, 1-pole, 100 A
- Flywheel, for use with friction clutch
- Silumin flywheel housing, SAE 1 flange
- Front-mounted engine suspension
- Particulate filters and SCR in compact exhaust gas aftertreatment system
- Open crankcase ventilation

ICFN - Continuous service: Rated output available 1/1 h. Unlimited h/year service time at a load factor of 100%.

Power charts

Power

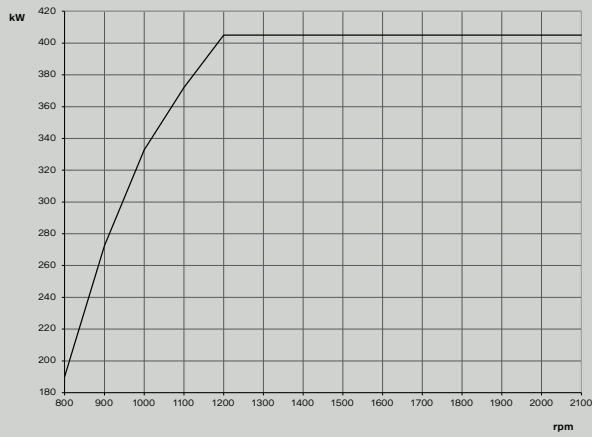

Torque

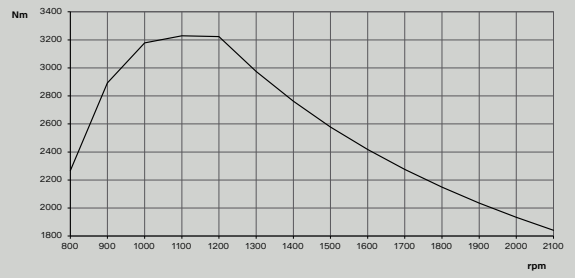

Fuel consumption

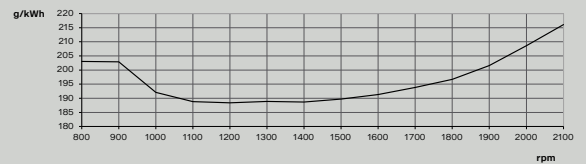

Reductant consumption

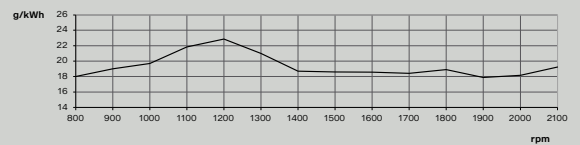

Test conditions: Air temperature 25°C. Barometric pressure 100 kPa (750 mmHg). Humidity 30%. Diesel fuel according to ECE R 24 Annex 6. Density of fuel 0.840 kg/dm³. Viscosity of fuel 3.0 cSt at 40°C. Energy value 42,700 kJ/kg. **Power test code:** ISO 3046. Power and fuel values ±3%.

Dimensions

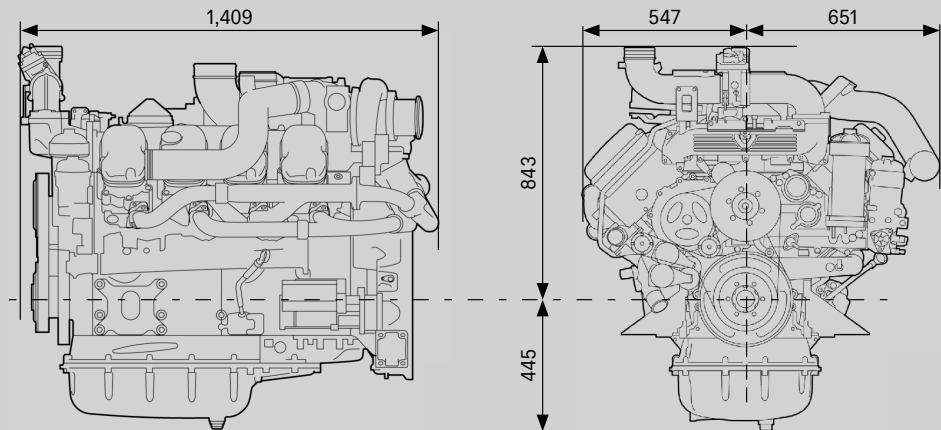

All dimensions indicated in mm.

Technical data

	Engine speed (rpm)			
	1,200	1,500	1,800	2,100
Gross power (kW)	405	405	405	405
Gross power (hp, metric)	551	551	551	551
Gross torque (Nm)	3,223	2,578	2,149	1,842
Fuel consumption at full load (g/kWh)	188	190	197	216
Reductant consumption at full load (g/kWh)	23	19	19	19
Heat rejection to coolant (kW)	143	139	143	167

EMISSION COMPLIANCE EU STAGE V

EXHAUST GAS AFTERTREATMENT SYSTEM

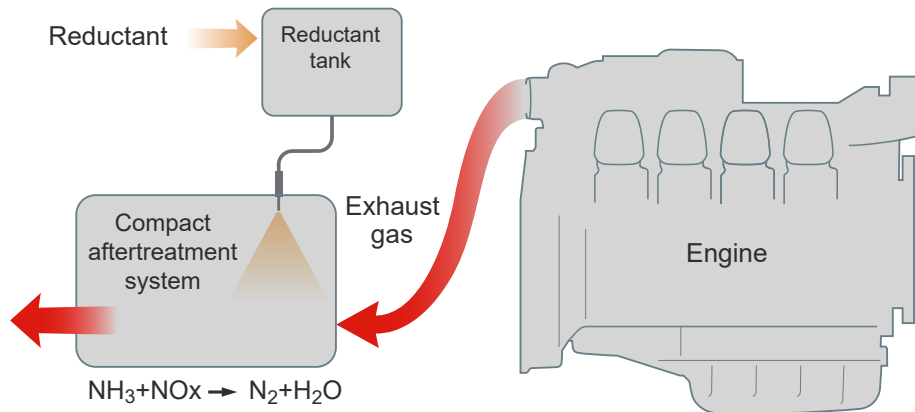

The emissions of particulate matter are filtered through a ceramic structure, that only allows particles smaller than a defined size to pass. When the filter is filled with soot particles to a specific amount, it is regenerated automatically.

SCR technology: A chemical process is started when reductant, a urea and water mixture, is injected into the exhaust gas stream. During injection, the water evaporates, and the urea breaks down to form ammonia. The ammonia then reacts with the nitrogen oxide gases in the catalytic converter and forms harmless products such as nitrogen gas and water.

SCR (Selective Catalytic Reduction) technology, in combination with particulate filters and an oxidation catalytic converter (integrated in the compact aftertreatment system), is used on Scania's EU Stage V engines to reduce the NOx and particle content in the exhaust gases in the best possible way.

Mechanical system

	Standard	Optional
1 Exhaust brake	-	✓
2 NOx flange upstream	✓	-
3 Exhaust bellows	-	✓
4 Exhaust flange	-	Ø130 mm, 155 mm
5 Exhaust bellows SCR	-	✓
6 Compact aftertreatment system	✓	-
7 NOx flange downstream	Ø127 mm, V-clamp	Ø130 mm, 155 mm
8 Reductant pressure hose	2.5 m	4 m, 5 m, 6.5 m
9 Reductant return hose	2.5 m	4 m, 5 m, 6.5 m
10 Reductant tank	38 l	45 l, 60 l, 63 l, 70 l
11 Reductant tank bleed hose	0.8 m	3.3 m
12 Coolant hose for heating of tank and pump	-	-
13 Coolant return hose	-	-

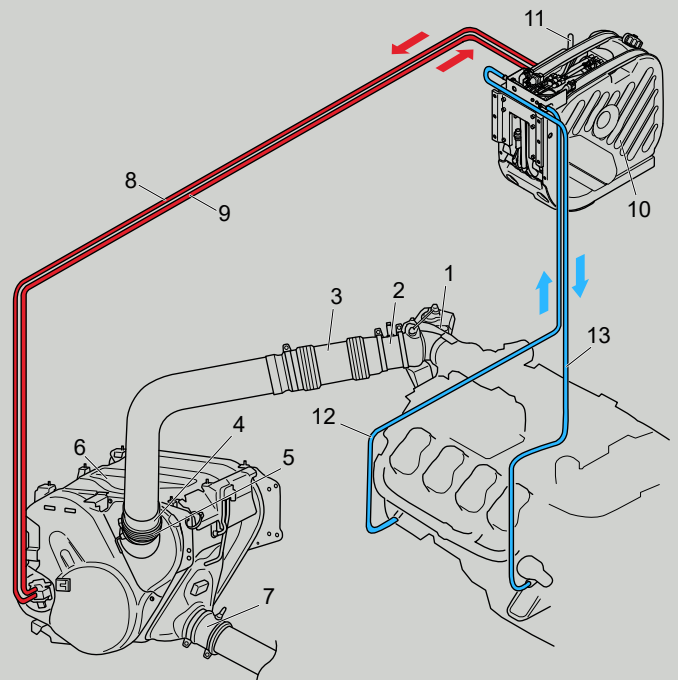

Electrical system

- 1 NOx sensor upstream with control unit
- 2 Exhaust gas temperature sensors
- 3 Differential pressure sensor
- 4 Exhaust gas temperature sensor
- 5 Reductant doser
- 6 NOx sensor downstream with control unit
- 7 Electrical interface to exhaust gas aftertreatment system

All components are standard equipment. Standard cable length 3.0 m, optional 4.5 m, 6 m (9 m)

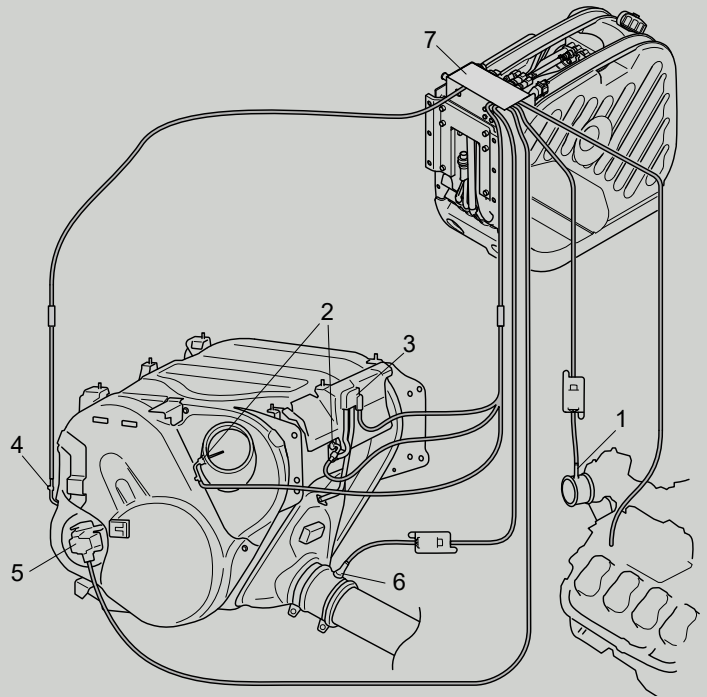

Compact aftertreatment system

Weight: 175 kg

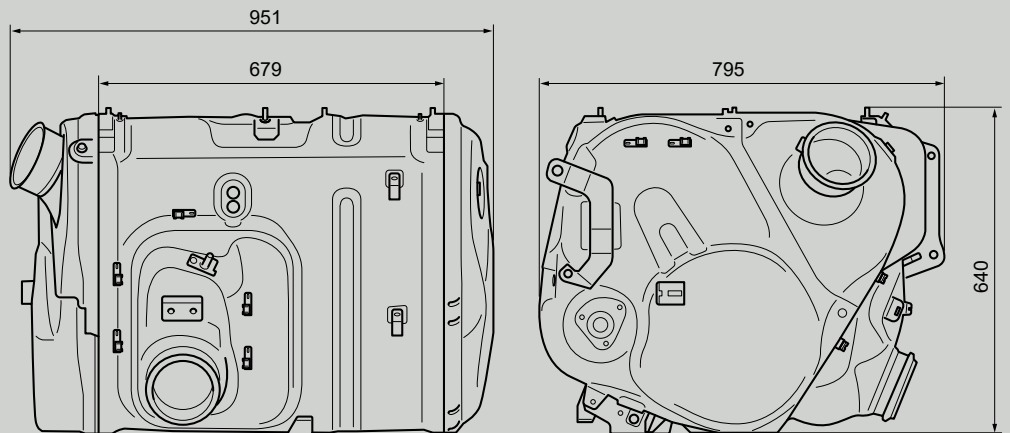

Reductant tank, 38 litres

Available sizes	Total volume	Filling volume
38 litres	50 litres	38 litres
45 litres	60 litres	45 litres
60 litres	75 litres	60 litres
63 litres	80 litres	63 litres
70 litres	90 litres	70 litres

