

DC13 076A. 257 kW (350 hp)

EU Stage IIIA, China Phase III, India Bharat Stage III and Brazil MAR-I

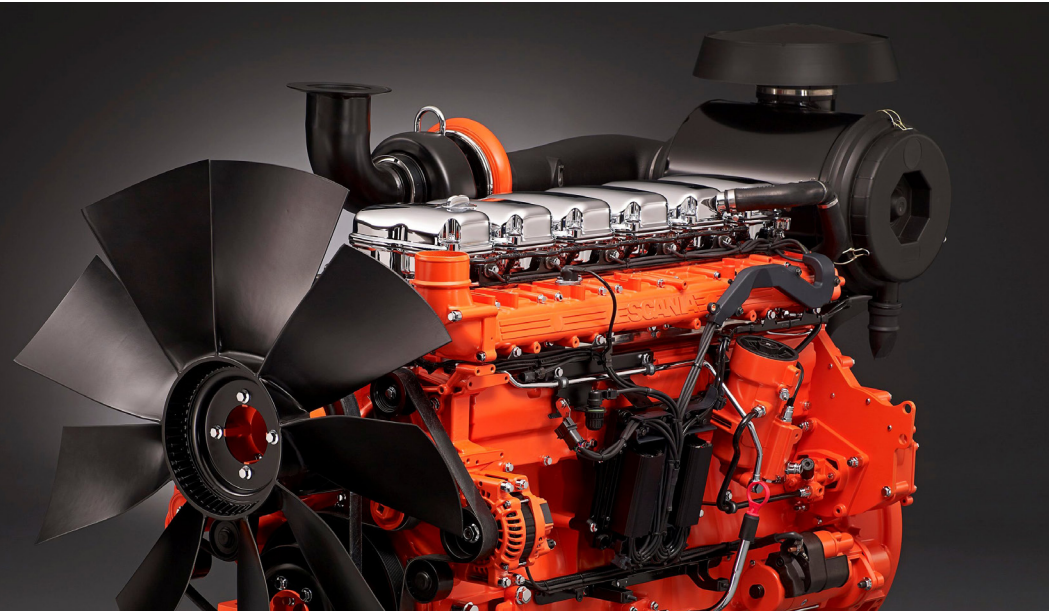

The industrial engines from Scania are based on a robust design with a strength optimised cylinder block containing wet cylinder liners that can easily be exchanged. Individual cylinder heads with 4 valves per cylinder promotes reparability and fuel economy.

The engine is equipped with a Scania developed Engine Management System, EMS, in order to ensure the control of all aspects related to engine performance. The injection system is based on electronically controlled unit injectors that give low exhaust emissions with good fuel economy and a high torque. The engine can be fitted with many accessories such as air cleaners, PTOs and flywheels in order to suit a variety of installations.

	Engine speed (rpm)			
	1200	1500	1800	2100
Gross power (kW)	202	257	257	257
Gross power (hp, metric)	275	350	350	350
Gross torque (Nm)	1607	1636	1363	1169
Spec fuel consumption. Full load (g/kWh)	188	208	220	238
Spec fuel consumption. 3/4 load (g/kWh)	195	214	232	256
Spec fuel consumption. 1/2 load (g/kWh)	200	219	245	279
Heat rejection to coolant (kW)	139	216	248	281

Rating: ICFN – Continuous service: Rated output available 1/1 h. Unlimited h/year service time at a load factor of 100%

Standard equipment

- Scania Engine Management System, EMS
- Unit injectors, PDE
- Turbocharger
- Saver ring in cylinder liner
- Fuel filter and extra pre-filter with water separator
- Oil filter, full flow
- Centrifugal oil cleaner
- Oil cooler, integrated in cylinder block
- Oil filler, in valve cover
- Deep front oil sump
- Oil dipstick, in cylinder block
- Magnetic drain plug for oil draining
- Starter motor, 1-pole 6.0 kW
- Alternator, 1-pole 100 A
- Flywheel, for use with friction clutch
- Silumin flywheel housing, SAE 1 flange
- Front mounted engine suspension
- Open crankcase ventilation

Optional equipment

- Cooling package
- Puller and pusher fans
- Fan ring with sealing
- Hydraulic pump
- Air compressor
- AC compressor
- Side-mounted PTO
- Front-mounted PTO
- Exhaust connections
- Engine heater
- Flywheels SAE11.5", SAE14", DANA15/16", DANA17" flexplate, ZF WG260
- Stiff rubber engine suspension
- Air cleaner
- Closed crankcase ventilation
- Studs in flywheel housing
- External thermostat for extra oil cooler
- Coolant level sensor
- Oil level sensor
- Low oil sump

DC13 076A. 257 kW (350 hp)

EU Stage IIIA, China Phase III, India Bharat

Stage III and Brazil MAR-I

Engine description

No of cylinders	6 in-line
Working principle	4-stroke
Firing order	1 - 5 - 3 - 6 - 2 - 4
Displacement	12.7 litres
Bore x stroke	130 x 160 mm
Compression ratio	17.3:1
Weight	1050 kg (excl oil and coolant)
Piston speed at 1500 rpm	8.0 m/s
Piston speed at 1800 rpm	9.6 m/s
Camshaft	High position alloy steel
Pistons	Steel pistons
Connection rods	I-section press forgings of alloy steel
Crankshaft	Alloy steel with hardened and polished bearing surfaces
Oil capacity	34-45 dm ³
Electrical system	1-pole 24V

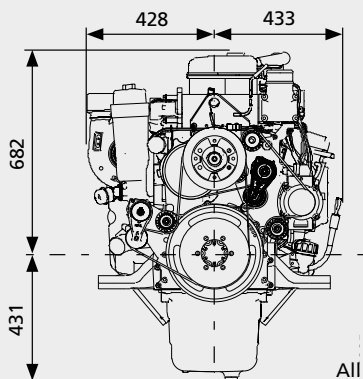
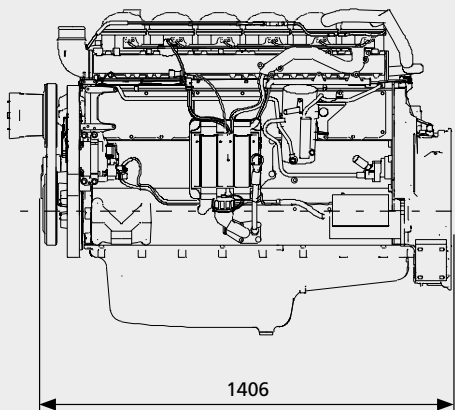

All dimensions in mm

Output

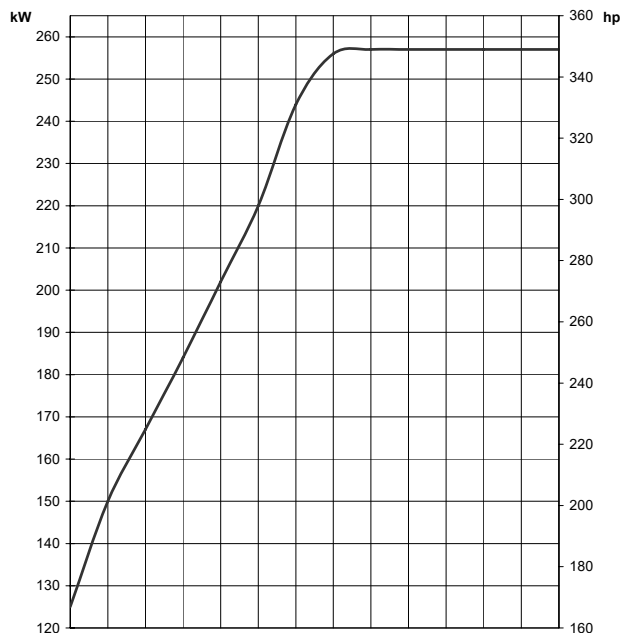

Torque

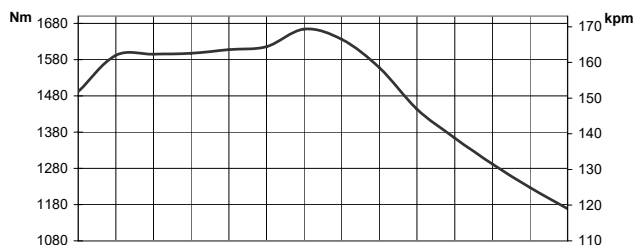

Spec fuel consumption

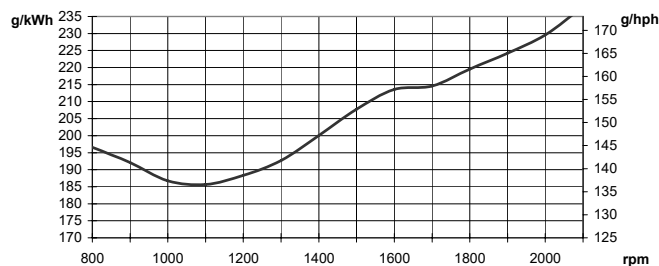

Test conditions Air temperature +25°C. Barometric pressure 100 kPa (750 mmHg). Humidity 30%. Diesel fuel acc. to ECE R 24 Annex 6. Density of fuel 0.840 kg/dm³. Viscosity of fuel 3.0 cSt at 40°C. Energy value 42700 kJ/kg. **Power test code** ISO 3046. Power and fuel values +/-3%.



SE 151 87 Södertälje, Sweden
 Telephone +46 8 553 810 00
 Telefax +46 8 553 829 93
www.scania.com
engines@scania.com